



UGANDA NATIONAL EXAMINATIONS BOARD

PRIMARY LEAVING EXAMINATION

2024

MATHEMATICS

Time Allowed: 2 hours 30 minutes

Random No.					Personal No.		

Candidate's Name:

Candidate's Signature:

District ID No.

--	--	--	--

Read the following instructions carefully:

- Do not write your school or district name anywhere on this paper.
- This paper has **two** sections: **A** and **B**. Section **A** has **20** questions and section **B** has **12** questions. The paper has **15 printed pages**.
- Answer **all** the questions. **All** the working for both sections **A** and **B** must be shown in the spaces provided.
- All** the working **must** be done using a **blue** or **black** ball point pen or ink. Any work done in pencil other than graphs and diagrams will **not** be marked.
- No calculators** are allowed in the examination room.
- Unnecessary **changes** in your work and handwriting that cannot be read easily may lead to **loss of marks**.
- Do not fill anything in the table indicated **"FOR EXAMINERS' USE ONLY"** and in the boxes inside the question paper.

FOR EXAMINERS' USE ONLY		
QN NO.	MARKS	EXR'S NO.
1 - 5		
6 - 10		
11 - 15		
16 - 20		
21 - 22		
23 - 24		
25 - 26		
27 - 28		
29 - 30		
31 - 32		
TOTAL		

SECTION A: 40 MARKS

Answer *all* the questions in this section.
Questions 1 to 20 carry two marks each.

1. Work out:

$$\begin{array}{r} 35 \\ \times 3 \\ \hline \end{array}$$

2. Write CXIV in Hindu Arabic numerals.
3. Given that $M = \{b, a, t\}$, write down all the subsets of set M.
4. Find a fraction equivalent to $\frac{4}{7}$.
5. Expand 3405 using powers of ten.



6. Using a ruler and a pair of compasses only, construct a right angle at point **R**.

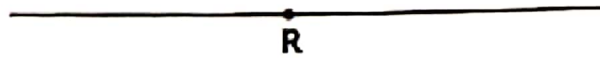

7. Given that $a = 3$, $b = 1$ and $n = 2$, find the value of $2a^n b$.

8. Find the next number in the sequence:

2, 3, 6, 11, 18,

9. It takes Ankunda 35 minutes to walk from school to home. If she arrived home at 12:20 p.m, what time did she leave school?

10. Otunu sold a goat and made a profit of sh 18,000. The cost price of the goat was sh 90,000. Calculate Otunu's percentage profit.

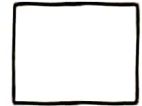

11. Find the largest number that divides both 24 and 18 without a remainder.

12. Work out: $42 - 21 \div 3$

13. The range of a set of scores is 23. The highest score is 76. Find the lowest score.

14. Find the perimeter of the figure below.

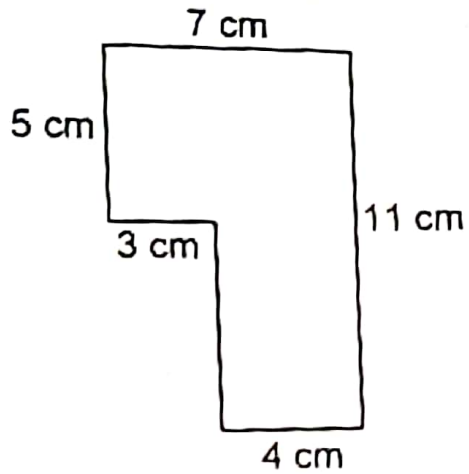

15. A school cook requires 24 kg of maize flour to feed 120 pupils. Find in grammes, the amount of maize flour the cook would require to feed 3 pupils.



16. Akiiki bought a suit at Kenya shillings (Ksh) 11,500. If the exchange rate was 1 Ksh = Ug.sh 32, how much money would Akiiki have paid for the suit in Uganda shillings (Ug.sh)?

17. Solve: $3 - 2y < 9$

18. The diagram below shows the position of a church (C) from a school (S).

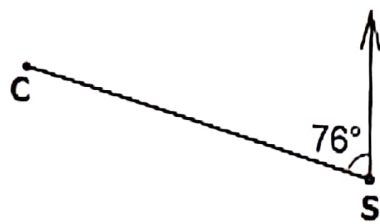

Find the bearing of the church from the school.

19. If today is Monday and a cake baked today can expire after 16 days, what day of the week will the cake expire?

20. One morning, the temperature on top of a mountain was -3°C . The temperature rose by 8°C in the afternoon. Find the afternoon temperature.

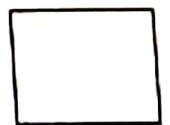

SECTION B: 60 MARKS

Answer all the questions in this section.
Marks for each question are indicated in the brackets.

21. Work out: $\frac{2.92 - 2.36}{0.068 + 0.012}$ (04 marks)

22. In a class, 31 pupils like volleyball (V) and k pupils like table tennis (T). 17 pupils like both games while 8 pupils do not like any of the two games. The number of pupils who like table tennis only is twice the number of those who do not like any of the two games.

- (a) Use the given information to complete the Venn diagram below. (04 marks)

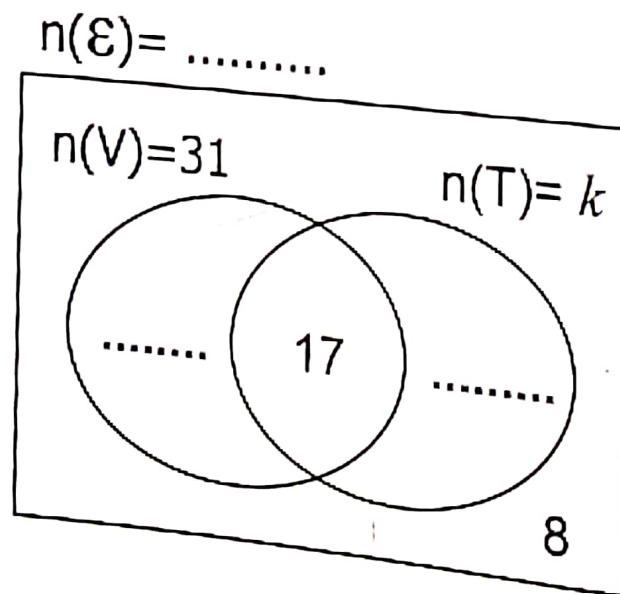

(b) Find;

(i) the value of k .

(01 mark)

(ii) the probability that a pupil picked at random from the class likes both volleyball and table tennis.

(01 mark)



23. A taxi and a bus were hired to transport people for a function. The taxi transports 14 people when full while the bus transports 69 people when full. The taxi made five trips and the bus made one trip. The taxi and the bus made the trips when full.

(a) Find the total number of people that were transported to the function.

(03 marks)

(b) The taxi owner was paid sh 56,000 per trip. Calculate the amount of money that was paid for each person.

(02 marks)

24. Given that $202_p = 1221_{\text{three}}$, find the value of p .

(04 marks)

25. The table below shows the amount of money Rukia paid for food stuff to a businesswoman after she was given a discount of sh 2,200.

(a) Study and complete the table.

(03 marks)

Item	Quantity	Cost per kg	Amount
Rice	4 kg	sh 3,800	sh
Beans kg	sh 5,000	sh 30,000
Irish Potatoes	0.5 kg	sh	sh 1,600
Total			sh 46,800

(b) Find how much money Rukia would have paid without the discount.

(02 marks)

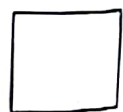

26. (a) Using a ruler and a pair of compasses only, construct a trapezium ABCD in which line $AB = 8$ cm, angle $DAB = \text{angle } ABC = 60^\circ$ and line $AD = BC = 3$ cm. (04 marks)

(b) Measure angle ADC. (01 mark)

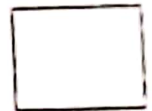

27. A motorcycle tyre made 40 complete turns to cover a distance of 5280 cm. Calculate the radius of the tyre. (Use $\pi = \frac{22}{7}$) (04 marks)

28. The pie chart below represents the population of four towns A, B, C and D. The population of town A is 3000 people and that of town B is 1800 people. Study the pie chart and use it to answer the questions that follow.

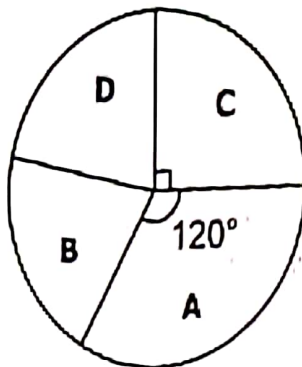

Calculate the population of;

- (a) town C.

(04 marks)

- (b) town D.

(02 marks)

29. (a) Solve: $\frac{5t - 6}{2} = t + 12$



(02 marks)

(b) Subtract $(2m - 3)$ from $(5m + 2)$.

(02 marks)

30. In the diagram below, angle $DAC = 37^\circ$, angle $BEC = 42^\circ$ and angle $BFD = 124^\circ$. Study the diagram and answer the questions that follow.

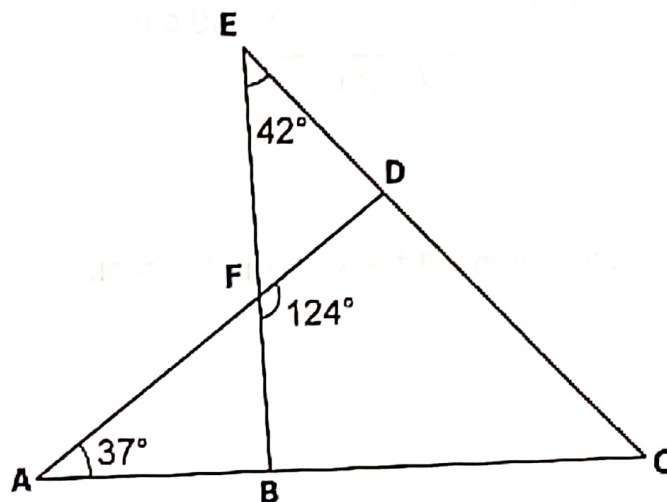

Find the size of;

(a) angle EBC.

(03 marks)

(b) angle DCA.

(02 marks)



31. The diagram below shows a tank with a rectangular base containing some water. Study and use it to answer the questions that follow.

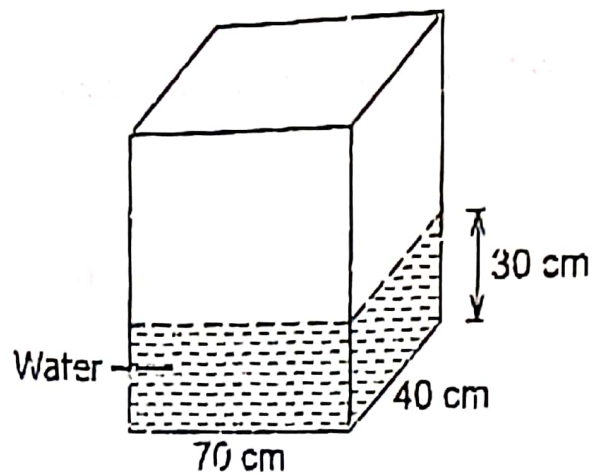

- (a) Calculate the volume of the water in the tank. (02 marks)
- (b) If 28 litres of the water was removed for washing clothes, calculate the height of the water that remained in the tank. (04 marks)

32. A motorcyclist left home for town at 8:00 a.m. riding at a speed of 40 km/h. After 30 minutes, he got a flat tyre which took him 45 minutes to repair. The distance between the home of the motorcyclist and town is 68 km.

(a) Find the distance the motorcyclist had covered before he got the flat tyre.

(02 marks)

(b) Calculate the speed at which the motorcyclist had to ride in order to reach town at 10:00 a.m. *(04 marks)*

